



TONE WINNER

YX-02

User Manual

ISO9001 Certified Enterprise



TONE WINNER

Product packing list

Number	Item	Quantity
1	Amplifier	1 pcs
2	Main speaker	2 pcs
3	Surround speaker	2 pcs
4	Subwoofer	1 pcs
5	User manual	1pcs
6	Power cord	1 pcs
7	HDMI cable	1 pcs
8	Quality certificate	1 pcs
9	Remote control	1pcs

Pollution Control Sign and Content Description



The symbol indicates that the product can be reused. The figure indicates the term of service of environmental protection. The product will not cause environmental pollution or affect human body and property within the term of service expressed by the figure since the date of manufacture as long as the safety and operating precautions on the product are obeyed.

Name and Content of Toxic or Harmful Substance or Element in the Product

Name of Parts	Toxic or Harmful Substance or Element					
	Lead Pb)	Mercury Hg)	Cadmium Cd)	Hexavalent chromium Cr)6+	Polybrominated (PBB)	Biphenyls polyphenyls (PBDE)
Body/Box	○	○	○	○	○	○
Equipped Baseplate/ Electrical Part	×	○	○	○	○	○
Plastic Structural Member	○	○	○	○	○	○
Metallic Structural Member	○	○	○	×	○	○
Cable	○	○	○	○	○	○
Transformer	○	○	○	○	○	○
Transformer Loudspeaker/ Microphone	×	○	○	×	○	○

Marks:

“○” means the content of the hazardous toxic substance is lower than SJ/T11363-2006 standard required.

“×” means in a homogeneous material of the component the content of the hazardous toxic substance is higher than SJ/T11363-2006 standard required.

Note: “×” as there are no substitutable substances under the existing technology

Thank you for using our audio products. With the philosophy of “high technology, high quality and high taste”, we make products with durable materials, exquisite technique, rigorous circuit & advanced technology and offer professional service!

Contents

Safety Warnings and Protective Measures-----2
Instructions Prior to Use-----4
Brief Introduction-----5
Features -----5
Front Panel -----7
Rear Panel -----8
Remote-----9
Speaker Installation Guide-----10
Connection Diagram-----11
Speaker System Connection Diagram-----12
Basic Use Setup-----12
Function Introduction & Set-----13
Phone Audio Wireless Transmission-----19
App -----19
Specification-----20
Equipment Safety Standard-----21
Problem Shooting-----21

Notice

1. Read the user manual carefully before you use the product.
2. Design, color and images will be dependent on the actual product.
3. The product or software might upgrade slightly without further notice.

Safety Warnings and Protective Measures

	WARNING ELECTRIC DANGER DO NOT OPEN		To reduce risk of electric shock, do not remove the outer cover (or rear panel). For maintenance, it should be carried out by qualified maintenance people. To avoid fire and electric shock hazards, do not get the unit wet or damp. Equipment safety standard : Class II
---	---	---	--

- 1 Read the protective measures: read all warning messages about protection and operation in the instructions carefully before using the equipment.
- 2 Follow instructions: please follow the instructions and do not violate the instructions.
- 3 Place the product on where manufacturer recommends: to avoid overturning, do not push too hard or suddenly stop when moving.
- 4 Keep away from water and moisture: do not place equipment near water such as bathtub, basin, sink, washing machine, etc. Do not use equipment at high temperatures or high humidity environment, such as a damp basement.
- 5 Cleaning: do not use liquid or mist cleaners. Please use dry cloth to clean. Turn off the machine and power off before cleaning the equipment.
- 6 Power supply: use the power supply according to marks and tags. Connect and place the wires properly. Do not step on wires to avoid damage. Pay special attention to wires to plugs, receptacles and connecting ports.
- 7 Ventilation: the cabinet of equipment is designed with venting holes. To ensure reliable performance, please avoid overheating and do not cover the equipment. Do not use the equipment on beds, sofas, carpets etc.
- 8 Keep away from heat: do not put that machine near heat sources, such as radiators, stoves and other objects that generate heat (including power amplifiers).
- 9 Prevent unknown objects or liquids - objects or liquids should be prevented from falling through the holes into the equipment, because it might contact with current or live parts that might cause fire or electric shock. Do not place the equipment in rain or water splashing place. Do not put water containers such as vases on top of it.
- 10 Please connect well all input/output wires before switching on.
- 11 Thunder and lightning: unplug the power cable in thunder and lightning weather because it can effectively prevent lightning impulses to protect the equipment.
- 12 Protections: unplug the machine when you do not use it for long period. Good grounding can prevent the machine from being damaged.

- 13 Maintenance: do not open the cabinet without professional instruction to avoid electric shock. Contact with the product managers where you buy this machine in the following cases:
- a) Unknown parts or liquid enter the machine.
 - b) The machine is soaked.
 - c) The machine works abnormally.
 - d) Machine falling or damage.

- 14 Battery: for environment protection, please dispose batteries in appropriate ways.

- 15 Disconnection device of main power supply: this machine uses power plug and coupler as the disconnecting devices. Power plug and coupler should be easily operated.

- 16 This product is only suitable for safe use in altitude below 2000m.



- 17 This product is not suitable to be used in tropical climates.



Instructions Prior to Use

■ General matters

- 1 Please place the machine at the well-ventilated place with accessible space 10 cm in width at its two sides, and above and behind it.
- 2 Don't apply oil, chemical solvent, volatile oil, paint or pesticide to the equipment.
- 3 Don't place the equipment in moist environment with the temperature being as high as above 60°C or extremely low.
- 4 Please keep the equipment away from direct exposure to sunlight, strong magnetic field, high temperature and electrical devices (computer, fax machine, etc.) which may cause interruption.
- 5 Please fixate the power socket when pulling out the power plug.
- 6 Do not open the cabinet without professional instruction to avoid electric shock. Contact with the product managers where you buy this machine for internal maintenance.
- 7 Please place the machine on flat, smooth and stable surface without vibration. Do not put things on top of the machine.
- 8 If there is no sound output, please turn off the machine and turn it on in 10 seconds.
- 9 Do not use the machine during a flashing lighting or thunderstorm. Pull out the plug for safety.

■ Warning

The voltage used for the machine must be consistent with that in the specifications. We assume no responsibilities for fires or other accidents due to the wrong use against the scope as specified.

Brief Introduction

YX-02 is a home cinema & Karaoke all-in-one Atmos sound speaker system specially designed for modern families. The device perfectly integrates the center speaker, Atmos theater decoder, Karaoke effector, and power amplifier into one.

5.1.4 speaker layout, applying wireless surround and wireless reflective ceiling channel technology. It has simple wiring and flexible placement.

YX-02 uses the most advanced audio technology Dolby Atmos, DTS:X and 3D 4K video technology, combined with film content, faithfully reproduce the real sound effects of various scenes, achieving the sound field effect of a professional-level Dolby Atmos sound effect cinema. The original 5.1.4 Dolby Atmos Karaoke system, powerful DSP digital reverberation technology, achieves professional level KTV sound effects to truly "move cinemas and KTVs home".

YX-02 also supports local wireless music playback from U disks and TF cards, supports Bluetooth lossless music transmission, USB external sound cards, mobile APP operations and other functions.

Features

Audio part

- Support Dolby Atmos, DolbyTrue HD and all downward Dolby audio formats.
- DTS:X, DTS-Master and all downward HD audio formats.
- Built-in auto smart room acoustic testing and auto test & compensation for room EQ, channel loudness and speaker distances. One-touch operation, full auto correction, & it supports manual adjustment at the same time.
- 5 bands(bass) + 11 bands(full frequency channel) EQ adjustment, parameters & diagrams will be displayed in the OSD at the same time.
- Independent settings and parameters storing for input channels.
- Power on default Karaoke & music volume set.
- 5.1.4 Atmos digital Karaoke effect, DSP digital Karaoke sound effect processing, level 9 anti-howling.
- Built-in Bluetooth audio receiver function.
- Built-in Bluetooth music wireless transmission.

- Built-in USB stick, EF card lossless music playing function.
- Support USB external sound card function, can connect PC digit audio input directly.
- Support HDMI eARC.
- With 1 way COAX, 1 way OPT and 1 way ANA stereo multi-function audio inputs.
- DRC intelligent audio processing technology.

Video part

- HDMI2.0 4 in 2 out, support HDCP2.2.
- Support 3D,4K HD video transmitting & processing, & compatible to all the downward video formats.
- Support Dolby Vision
- Support HDR10.
- HLG color enhance technology.
- Big OSD display for menu management & set.
- Support HDMI CEC
- Support HDMI video output mode management.

Other functions

- Support Apps control, & local music information synchronous display on both OSD & Apps.
- Built-in a 5x22W(8Ω, RMS) HD amplifier.
- With subwoofer 75W(2Ω, RMS) amplifier output, it can driver a standard 8" subwoofer directly, & it also has bass signal output for connecting active subwoofer.
- Support power on volume set & max volume restriction for mic & music.

Front Panel

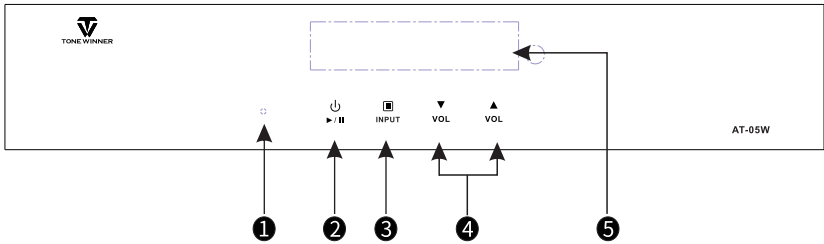

① Standby Indicator

The indicator is red when the device is on standby.

② Power Key

- When playing music from TF card, USB disk, press this key will pause & resume playing.
- When playing external signal, press this key will mute or unmute.
- When it's in normal playing (completely quiet relative menu), hold this key will power off the unit, & when the unit is standby, press this key will turn the unit on.

③ INPUT

Signal source input button, press this key & match with "▲" "▼" move the cursor to corresponding input source, & press this key again for confirm the selected source.

④ VOL/▲ VOL/▼

- When it's in normal playing (completely quiet relative menu), press the keys to increase & decrease the main volume.
- When the unit is in mute, press this key will unmute.
- Under input status, press these keys for moving cursor up & down.

⑤ Display Screen

Display signal source, volume and operating information.

Rear Panel

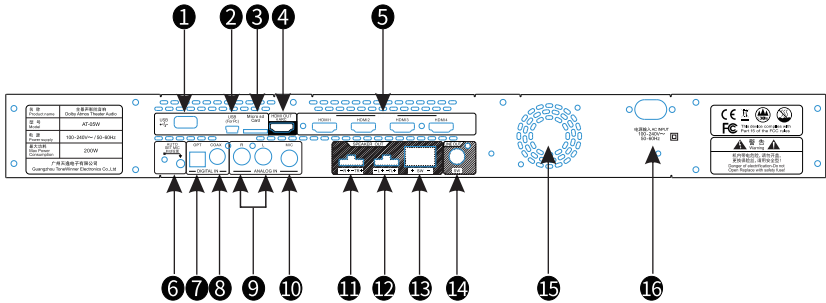

① USB

USB input port.

② USB(FOR PC)

For directly connection of computer digital audio input to work as external sound card.

③ Micro SD Card

TF card input port.

④ HDMI OUT eARC

Connect to display device with HDMI input port, meanwhile the port support eARC, if the connected display device is with eARC function, then the audio can be returned to AT-02.

⑤ HDMI IN

There are 4 HDMI input ports, for connecting devices with HDMI output.

⑥ AUTO SET MIC

Auto acoustic test microphone input port, it can gather auto room scanning information when connect with a matched mic.

⑦ OPT

Digital audio optical port.

⑧ COAX

Digital audio coaxial port.

⑨ ANALOG IN L/R

Stereo analog audio input port.

⑩ ANALOG IN MIC

Mic input port.

⑪ SPEAKER OUT-R+/-TR+

Right channel speaker port.

⑫ SPEAKER OUT-L+/-TL+

Left channel speaker port.

13 SPEAKER OUT-SW+

Subwoofer port.

14 LINE OUT SW

Active subwoofer signal line out port.

15 Fan port

Remark: Venting port, do not block.

16 Power input(100-240V~/50-60Hz) auto switch power supply

Remote

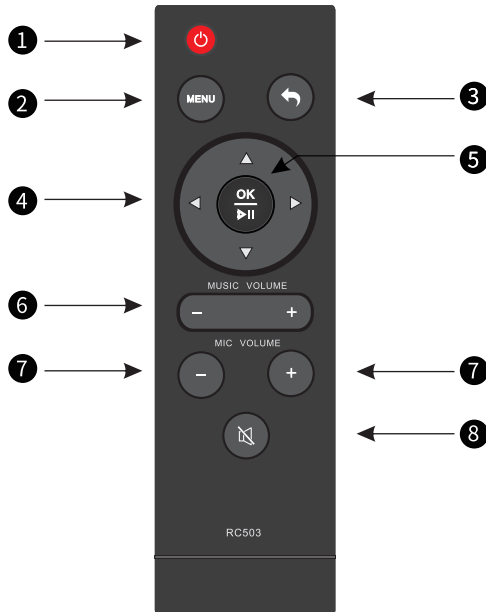

Notice:

1. Please make sure to put the positive and negative ends of batteries correctly.
2. Please donot mix-use old & new batteries
3. Please take out all batteries if the remote is not in use for a long time to avoid damage causedby battery leakage.
4. Please replace the batteries when the effective range of the remote is reducing or the signal transmission is not stable.
5. Please use soft cloth to regularly clear the IR diode on the remote and the remote controlsensor on the front panel.
6. Please don't put the remote in a moist or sultry place and avoid hitting & shaking.
7. Please select AAA batteries for the remote.

1 Power Key

Under OFF status: Press this key to power on.

Under ON status: Hold this key to power off, press this key, the OSD will display: "Power off" & ask whether to power off with OSD displays "OFF, Y", press OK button to confirm.

2 MENU

Press this button, the OSD menu will be displayed, the unit's screen will show "MENU", you can select different functions & do the setting with direction buttons. Then press MENU button again to quit OSD menu.

3 Return key

Return to previous menu.

4 ▲, ▼, ◀, ▶ direction buttons

- Use these direction buttons to operate OSD menu & trimming.
- Under normal playing (complete quit relative menu) status, use ▲ ▼ buttons to switch signal.
- Under local playing, ◀ ▶ Short press for switching Next/Last track, long press for fast-forward & rewind.

5 OK/ ▶ II key

- For confirm/playback (pause) options.
- Hold it for 2 seconds to turn on Karaoke.

6 Music volume button

7 Mic volume button

8 Mute button

Under normal playing, press this key, the big OSD will keep showing mute symbol, the volume number character on unit screen will keep flashing. Press it again will unmute.

Speaker installation guide:

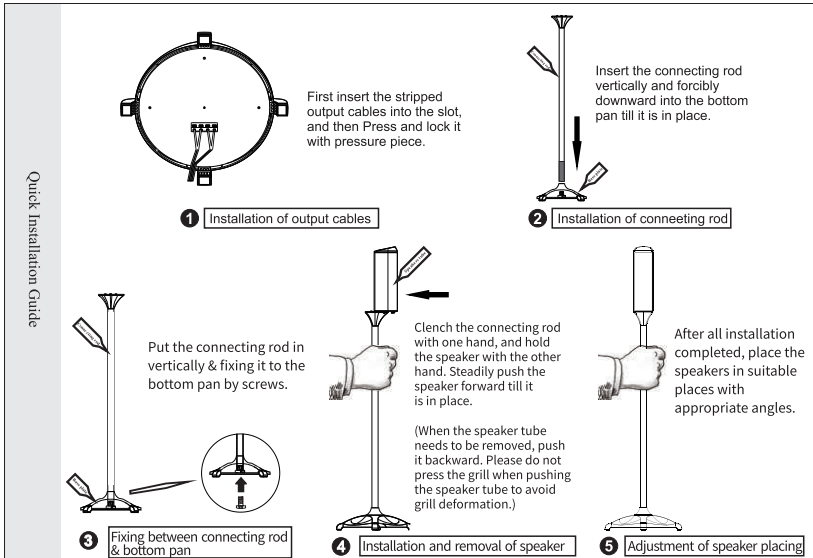

Connection Diagram (Speakers Placing Instruction)

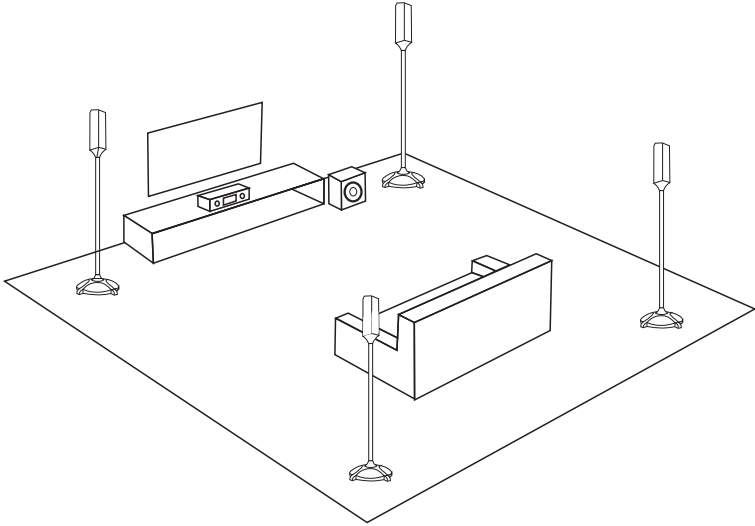

YX-02 Speakers placement diagram

- ① Front left, right speakers are designed with front left top driver, front right top driver built-in, the top channel speakers toward to ceiling & create top audio effect by ceiling reflection.
- ② Center speaker is integrated to the amplifier, the two drivers for center channel is on the left & right side of the display screen of center speaker, please do not block them when placing the amplifier.
- ③ The wireless surround left & right speakers are designed with rear left & right top speakers, & the top channel speakers toward to ceiling & create top audio effect by ceiling reflection.
- ④ Passive subwoofer, it plays bass audio.

Speaker system connecting diagram

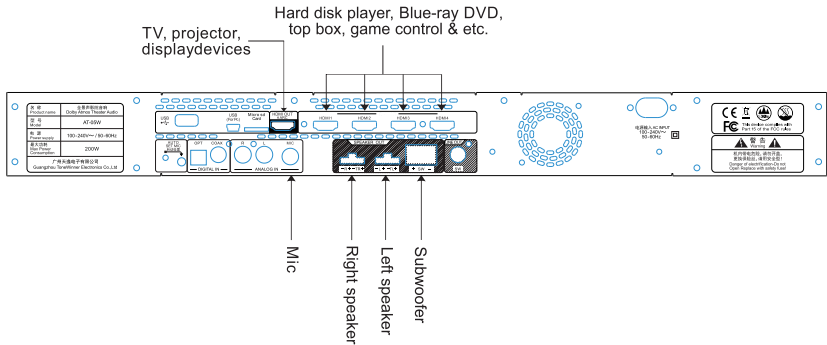

Basic use setup(Initial system debugging instruction)

- 1. Language set:** English/中文, default set is English
Main menu--System set--Function option--Language/语言
- 2. Left/Right wireless surround speakers pairing**
Main menu--System set--Speaker set--Left/Right wireless surround speakers pairing.
(Remark: Please distinguish left & right speakers.)
- 3. Speaker distance (Latency)**
Main menu--System set--Speaker set--Speaker distance: Set distances between each speaker & our sitting place, the system will do auto convert latency.
- 4. Level test/compensation**
Test if the location of each channel is correct & do adjustment to volume gain of different channels, in order to make the sound field correct & have balance sound effect. The system will turn off the channels which don't need parameters adjustment based on the speaker layout you selected.
- 5. Mic switch**
 - a. Main menu--Karaoke--Karaoke switch. (Note: The set is only valid for one time.)
 - b. Main menu--System set--Input source set--Signal source channels set--Confirm.
(Note: The set is always valid, when switch to this signal sour channel during using, the mic function will be auto ON.)
- 6. Select relative signal source input port**
 - a. Press direction buttons on remote to switch to relative signal source which are with signal input.
 - b. Select via front panel buttons.
 - c. Select via OSD menu audio source input.

Function introduction and set:

I Input selection:

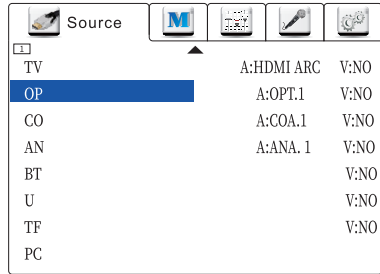
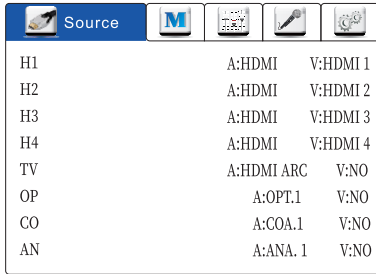

Offering all signal input selection function, & displaying audio video source input.

II Mode selection

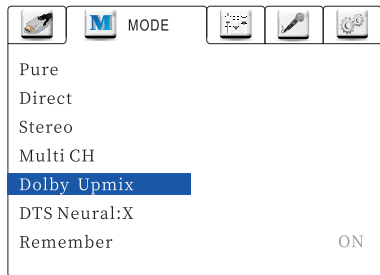
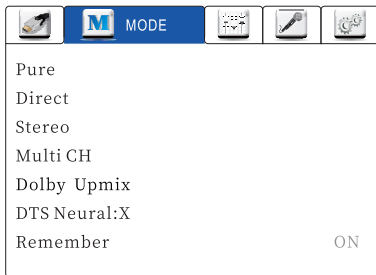

It will only do DSP sound effect processing to current input source, instead of setting to all the input signal sources.

It offers: Pure audio, Direct, Stereo, Multi channel, Dolby sound, DTS sound & etc 6 kinds of modes for option. (Current mode selection, after reboot it will restore to default sets.)

III Parameters adjustment

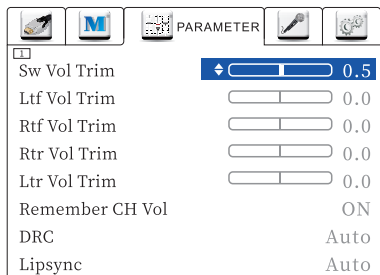
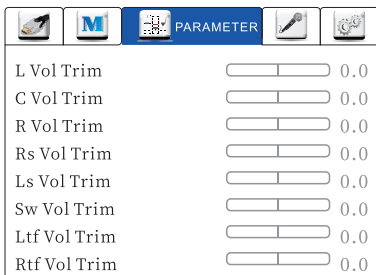

For each channel, it has independent output level gain adjustment, & users can adjust the loudness gap among different speakers' loudness to make the sound filed in balance. The available adjustable parameters display of different speakers are different.

If the channel is not available in the speaker layout, it will be displayed in gray & can't be adjusted.

Channel volume power off memory: ON/OFF

DRC: Auto (bass compression dynamics) ON/OFF

Lip sync time: Auto

IV Karaoke (Mic set)

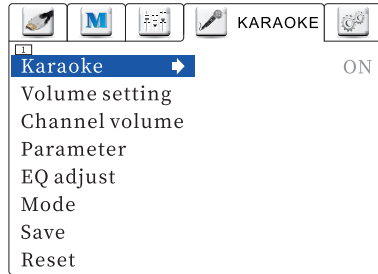
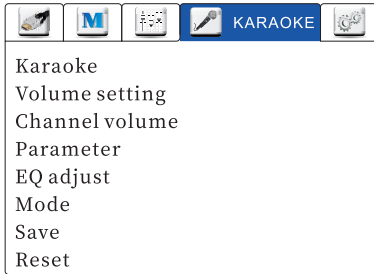

A. Karaoke ON:

Karaoke ON/OFF set.

Only when Karaoke is set as ON, you can move cursor to do relative set under various menus.

B. Volume set:

It offers Mic volume, startup Mic volume, Mic max volume.

To avoid unnecessary damage of the device during use, please set the maximum volume limit and set the Karaoke startup volume according to personal preferences;

C. Channel volume:

Set the mic volume of the corresponding channel when using karaoke: Mic center volume, Mic bass volume, and Mic surround volume, each adjustable by $\pm 12\text{dB}$.

D. Mic parameters:

It offers: parameter adjustments such as howling suppression, effect volume, echo delay, echo intensity, echo times, reverberation delay, reverberation intensity phase, choral delay, choral intensity, effect phase.

Howling suppression: When using karaoke, if howling occurs, please turn on the howling suppression. In actual use, please select the appropriate frequency shift frequency according to the actual environment. The unit offers 9 frequency shift points in total.

Effect volume: Effect adjust intensity, 0-10 adjustable, adjust step is 0.5.

Echo delay: 50-300ms adjustable, adjust step is 25ms.

Echo intensity: Adjust the echo times of vocals from Mic, adjustable from 0-10.

Echo times: Adjust echo loudness of vocals from Mic, adjustable from 0-10.

Reverberation times: Adjust reverberation time of vocals from Mic, adjustable from 0-10.

Reverberation intensity: Adjust the reverberation strength of vocals from Mic, adjustable from 0-10.

Choral delay: 50-300ms adjustable, adjust step is 25ms.

Choral intensity: 0-10 adjustable, adjust step is 0.5.

Effect phase: 1-6 adjustable.

E. Tone trims

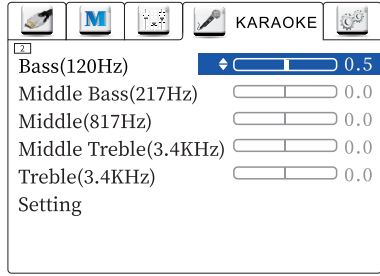
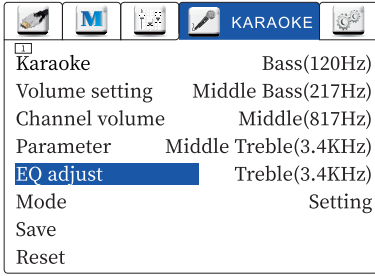

In order to make it convenient for users to do tone trims, the unit offers 5 point fixed frequencies (bass, mid-bass, mid-range, mid-treble, treble). Mic sound effect and effector sound effect can be adjusted under advanced setting respectively. Mic sound effect provides 5-point parameter equalization for adjustment.

F. Mic mode:

It has factory mode, user mode.

Factory mode: With 20 different styles built-in sound effects for option.

User mode: Users can adjust and save modes based on their own sound styles, 3 types in total.

G. Effect saving:

Please save adjusted results according to your favorite sound style, otherwise the adjusted Karaoke options will loose after shutting down.

H. Restore factory settings:

Only the relevant parameters set in the "Karaoke" menu will be restored to the factory default.

V System set:

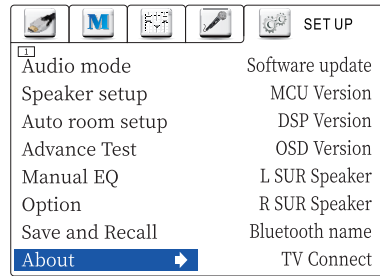
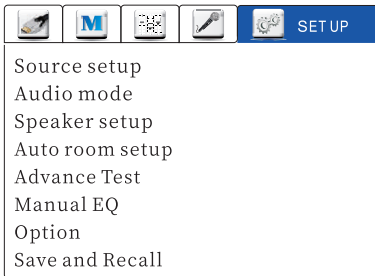

It offers: input source set, audio mode, speaker set, automatic acoustic test, advanced acoustic test, EQ set/ function options, parameter saving and restoration, and device information in total 9 settings.

A. Input source settings: Set ON/OFF for each channel, EQ mode selection, Karaoke ON/OFF, and default settings.

- 1) Switch: Set ON/OFF status of each input source. (If this is turned off, its signal input port will not be displayed.)
- 2) EQ selection: Theater mode, Music mode, Karaoke mode, automatic EQ, Pass-through mode, and System synchronization, in total 6 modes. (Recommendation: select the mode according to the wiring method)
- 3) Factory default set.

B. Audio mode: Set each input signal to your preferred sound effect mode.

Input signal: Play back the input signal as Pure audio, Pass-through, Stereo, Multi-channel, Dolby sound effects, DTS sound effects and other modes.

(This set to take effect till you change it.)

C. Speaker settings:

It offers level test/compensation, speaker distance, left and right surround speaker pairing, and clear pairing.

- 1) Level test/compensation: Test whether the position of each channel is correct and adjust the volume gain of different channels in order to make sure the sound field is correct and achieve balanced sound.
- 2) Speaker distance (Latency): Just enter the distance from each speaker to the same listening position, and the system will automatically adjust the speaker latency to achieve a better listening effect.
- 3) Pairing of left and right speakers: After selecting the corresponding channel and confirming, follow the prompts to complete the pairing. (Note: Please distinguish between left and right speakers)

D. Auto acoustic test

- 1) Insert the acoustic test Mic into the AUTO SET MIC port.
- 2) Place the test Mic at the listening position.
- 3) Confirm to start auto acoustic test.
- 4) After level test, it will enter frequency response test.
- 5) After all channels tests are completed, press Confirm to apply. If you need to give up, move the cursor to Discard and press Confirm.

E. Advanced acoustic test

- 1) After entering advance acoustic test, select level test and distance test.
- 2) After the test is completed, if you want to use it, press OK. If you don't want to use it, just discard it.
- 3) EQ test: Each channel can be tested independently.
- 4) The specific test steps for each channel are the same as the auto test. (The speakers' detailed distances will be displayed after the test is completed.)

F. EQ settings

It offers 5 different modes for users to use: Theater mode, Music mode, Karaoke mode, Auto EQ, and Pass-through mode. Among them, Theater mode, Music mode, Karaoke mode, and Auto EQ provide parametric equalization parameter adjustment for different channels: 11 bands for left and right channels, 11 bands for center channel, 7 bands for left and right surround channels, 7 bands for ceiling channels, and 5 bands for subwoofer.

G. Function options:

It provides: Language/语言, start-up settings, HDMI options, information display settings, no signal standby, unit, U disk record logs.

1) Language option: Chinese and English.

2) Start-up settings:

Power on: Auto power on when power is connected.

Standby: When unit is in standby mode, you will need to power on by manual.

The previous state before power cut out will be remembered. If the power is cut off in the standby state, it will be in standby when the power is turned on; if it's cut off when it is in working state, it will automatically turn on.

3)HDMI options:

Synchronize to TV power, Standby pass-through, CEC signal source switching, HDMI signal format.

① Synchronize to TV power: There are two options: "On" or "Off". If it's turned ON, when the TV is turned on, the amplifier will be turned on automatically simultaneously, and if it's turned off, the power amplifier needs to be turned on by manual separately.

② Standby pass-through: If turn on standby pass-through, when the device is powered on and in standby mode, the audio and video signals will be directly output to the display device (TV or projector), when it is turned off, this function will not work.

③ CEC signal source switch: If this function is turned on, & the power amplifier is turned on, when an external HDMI CEC device (such as a DVD) is powered on or in playing, the power amplifier will automatically switches to the corresponding HDMI channel, no need user to switch the input signal source. It is necessary to ensure the connection is normal. (This function only supports HDMI ARC output port, recommend to turn it off to avoid incorrect operation).

④ HDMI Signal format: EDID audio in priority ON/OFF.

There are "Auto", "Standard", "Enhance" and "Enhance+"4 modes for option, enhance mode displays high-quality HDMI signals.

Auto: Adapt to the resolution of the connected display device.

Standard: Support HDMI1.4a format.

Enhance: Support HDMI2.0 (4K/60H2) format.

Enhance+:Support HDR (increase brightness & contrast of video) format.

4)Information display set:

It offers: display screen brightness adjustment, information window content, information window position, screen menu transparency setting.

① Display brightness adjustment: The screen of power amplifier display brightness adjustment, 1-4 levels adjustable.

② Information window content: The content of the playback source is displayed. (You can set it as: not displayed, only display volume and display all information.)

③ Information window position: The position where the information content is displayed (top or bottom).

④ OSD menu transparency set: OSD menu transparency set, 0-7 levels adjustable.

5) No-signal standby:

The power amplifier's wait time for running into standby when there is no input signal.

6) Distance Unit: metric/inch (this only applies to speaker distance).

7) USB stick log record: Default set as OFF. When the unit fails, user can plug in a USB stick for recording the fault information & generates a file for the manufacturer to analyze the problem.

H. Parameter saving and restore

① Parameters backup: Back up all currently set parameters.

② Load backup parameters: Restore all latest saved parameters.

③ Restore factory set: Restore the device to its factory default settings (all adjusted data will be cleared, please proceed it with caution.)

I. Device information:

Software upgrade, MCU version, DSP version, DSD version, left/right surround version, Bluetooth name, TV connection, more information.

① Software update: When you need to update the software, copy the update file to the directory of a USB stick with a capacity of less than 16GB and in a format of FAT32, and insert it into the unit's USB port and follow the prompts to update software for the unit. You can also update the software of the unit by reboot it & it will run automatically update during the startup.

Phone Audio Wireless Transmission:

- (1) Select BT audio source on the front panel or remote.
- (2) Switch on Bluetooth on your mobile phone, search & pair-connect with AVR-BT, you can play music playback on your phone after connect successfully.

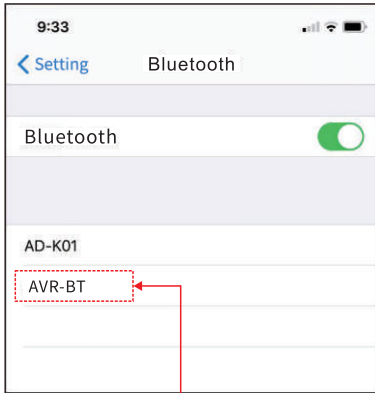

Press to connect

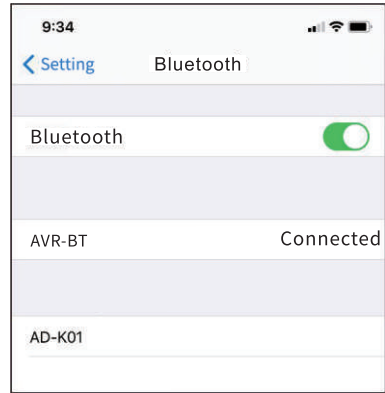

Apps:

For better user experience, ToneWinner has developed its own App to match its products and you can finish all above operations and switches on your mobile phone. For the first time to use ToneWinner App, please follow step 1, 2 and 3. After that you just need to follow step 4 only:



- (1) Let YX-02 at normal working status.
- (2) Scan the QR code at right side for downloading the ToneWinner Music App and install it.
- (3) Open the app, & find device name AT-05 & click for connection. The phone will auto switch to the same audio source of the unit, & then you can control the unit over apps.
- (4) For more apps operation details, please check on ToneWinner's website.

Specification

Executive standard: GB/T9254.1, GB4943.1, GB17625.1

Part NO: AT-05W

Power output: L/R/C/SL/SR/TL/TR one channel driven: 150W (p-p output power)
22W (RMS/8Ω, THD=1%)

SW channel:500W (p-p output power)
75W (RMS/2Ω, THD=1%)

Frequency response: 20Hz-20kHz

S/N: ≥90dB(A weighted)

Distortion: <0.5% (1kHz, normal working status)

Power voltage: 100-240V~/50-60Hz

Dimension: 550 x 138 x 66.3mm (W X D X H)

NW: 2.8kgs

Part NO: AS-05F

Driver size:2.25" x1 + 3" x2

Dimension: 313 x 313 x 1160mm (W X D X H)

NW: 4.2kgs

Part NO: AS-05WS

Driver size:2.25" x1 + 3" x2

Power voltage: 100-240V~/50-60Hz

Dimension: 313 x 313 x 1160mm (W X D X H)

NW: 4.4kgs

Part NO: SW-05

Driver size: 8" x1

Dimension: 260 x 310 x 293mm (W X D X H, including feet & grills)

NW: 6.5kgs

Equipment Safety Standard: Class II

- 1 Please read the manual and safety precautions carefully before using.
- 2 The product should be mounted somewhere ventilated and dry for the convenience of heat dissipation to avoid moisture and lampblack.
- 3 The safety standard of the machine is Class II; upon installation, the power plug should be connected to 100-240V~/50-60Hz grid.
- 4 Do not remove the cover during using to prevent electrocution.
- 5 Do not frequently turn it on or off. Wait a few minutes before turning it on again.
- 6 When the equipment fails, contact with the product managers where you buy this machine for internal maintenance. To avoid accident, do not open the rear cover for inspection or repair.
- 7 The plugs, power lines, fuses, power switch, and transformer used on the equipment are all safety parts. Upon change of safety parts, the maintenance department should replace them in accordance with the model and specification specified by our company.

Problem Shooting

If a problem arise, please check the possible reason shown in below chart before you contact for service:

Problem	Reason	Solution
No display on the screen.	The power cord is connected loosely.	Connect the power cord correctly.
	The unit is not ON.	Press the power button.
No sound output.	The audio cables are connected loosely.	Disconnect the audio cables and connect them correctly.
	Incorrect settings of the connected devices.	Select and set the audio input channels of the connected devices. Reboot the unit if needed
Broken sound output or sound distortion.	The audio cables are connected loosely.	Disconnect the audio cables and correctly connect them again.
Remote control does not work.	Remote control is blocked or not aimed correctly.	Clear the block or aim it to the IR receiving window.
	Too far from the unit.	Use the remote control within 7 meters.
	The battery has run down.	Change the batteries.
Front panel button does not work.	The current flows too much or the static electricity interrupts the normal working.	Power off the unit and power on it again.
Local play error	Data error	Settings--clear data.



Scan QR code

Guangzhou ToneWinner Electronics Co., Ltd

Tel.: 86-020-34797660/34796146

Web: en.tonewinner.com

Address: NO.1, Hongsheng 3rd Road, Dashi Street,
Panyu District, Guangzhou, 511430, China